

Name: _____

Pyramid and Cone

1) Find the lateral area of each cone

1)

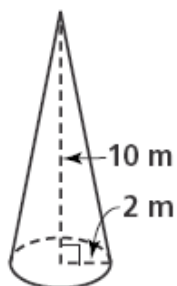

2)

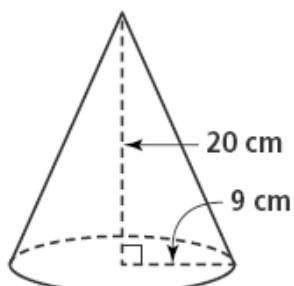

3)

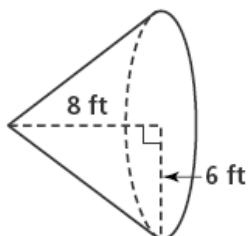

4)

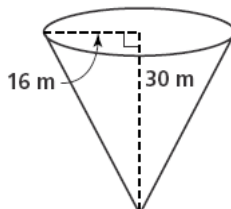

5)

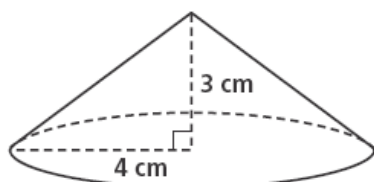

6)

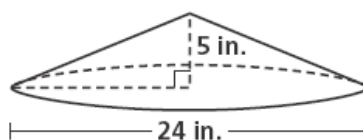

2) Find the volume of each cone.

1)

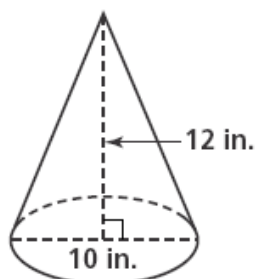

2)

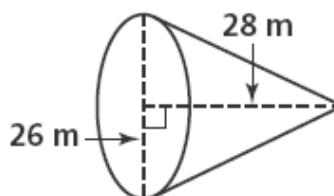

3)

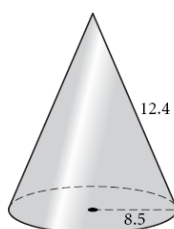

3) Find the volume of each pyramid.

1)

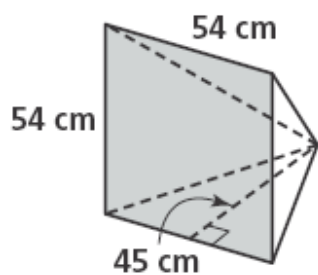

2)

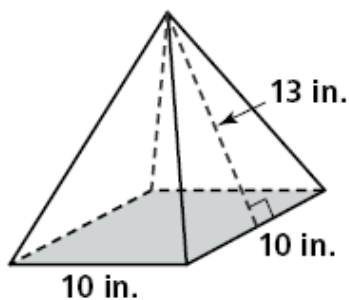

3)

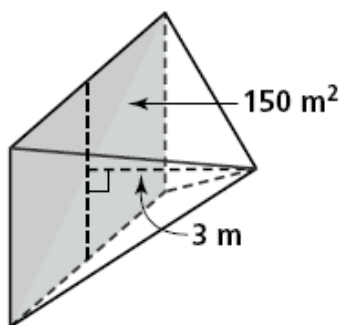

4)

